

# EasyPhos

## Quick Start Guide



**Installazione**  
**Installation**

[www.mantaecologica.com](http://www.mantaecologica.com)

Ad ogni smontaggio  
mantenere gli O-Ring  
LUBRIFICATI con grasso  
siliconico.

At each disassembly,  
maintain the O-Rings  
lubricated with silicone  
grease.

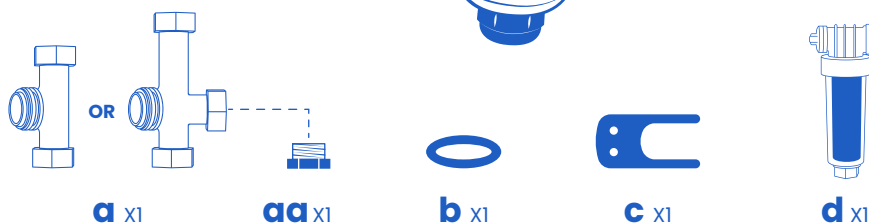
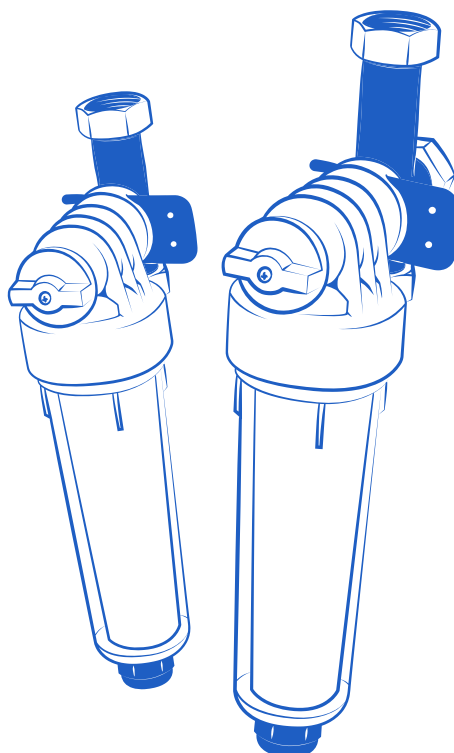

### Installazione - Installation

### Manutenzione - Maintenance

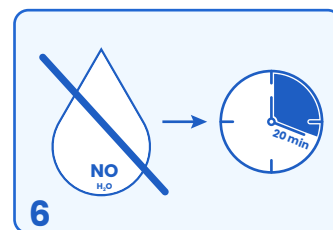
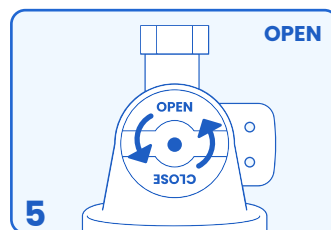
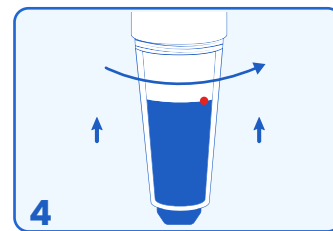
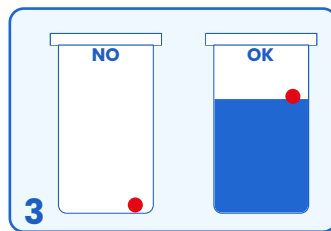
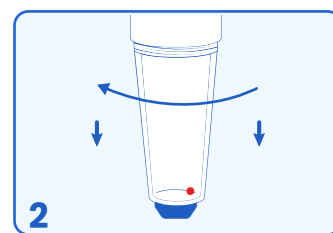
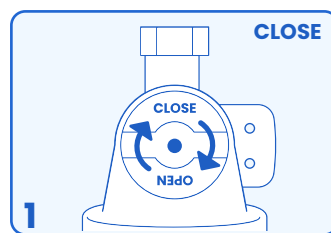
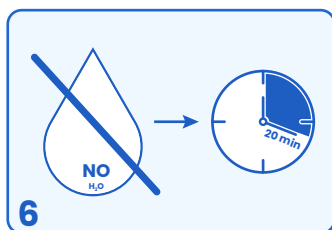
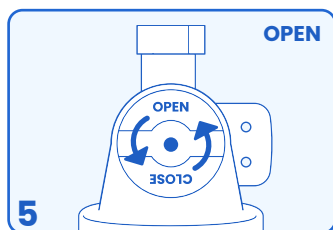
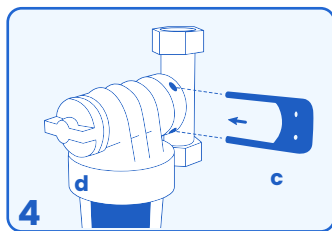
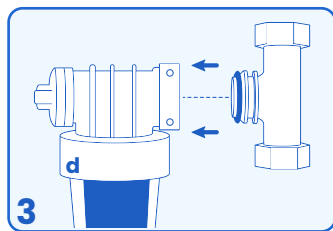
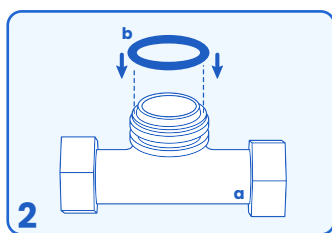
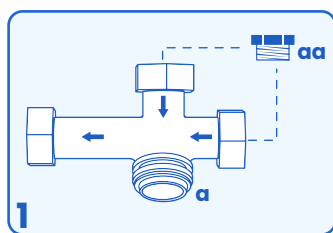

# Garanzia a Vita

La garanzia copre a vita tutti i difetti di fabbrica.

Rimane valida effettuando la normale manutenzione del filtro: sufficiente sostituire la cartuccia annualmente secondo quanto previsto dal manuale e registrarne l'acquisto.



Scansiona il QR-Code  
Scopri tutte le informazioni

[www.mantaecologica.com/garanzia-a-vita](http://www.mantaecologica.com/garanzia-a-vita)

# Lifetime Warranty

The warranty covers all manufacturing defects for life.

It remains valid provided regular maintenance of the equipment is carried out: simply replace cartridges and consumables annually as specified in the manual and register the purchase of the consumable.



Scan the QR code  
Discover all the information

[www.mantaecologica.com/en/lifetime-warranty](http://www.mantaecologica.com/en/lifetime-warranty)

## Dove puoi comprare i consumabili e le ricariche

### DAL TUO FORNITORE DI FIDUCIA

Acquista ricariche e consumabili dal tuo fornitore di fiducia e mantieni attiva la Garanzia a Vita della linea Easy.

1. **Accedi** al software Garanzia Easy su [www.garanziamanta.it](http://www.garanziamanta.it)
2. **Clicca** su **"Garanzia a vita linea Easy"** e successivamente sul pulsante **"Accedi"**.
3. **Inserisci il codice rivenditore**. Se non lo conosci, richiedilo al professionista che ha venduto o installato l'apparecchio.
4. **Compila i dati richiesti e inserisci il numero seriale** presente sull'adesivo argentato applicato sull'apparecchio.
5. **Nell'ultima schermata firma con il dito** per confermare il consenso privacy necessario alla registrazione.

Registrare l'acquisto dei consumabili è semplice e ti permette di mantenere valida la Garanzia a Vita della linea Easy.

### STORE MANTA ECOLOGICA

Se non trovi le ricariche dal tuo fornitore di fiducia, puoi acquistarle sul nostro store [www.mantaricariche.it](http://www.mantaricariche.it)

1. **Inserisci il Numero seriale** del dispositivo
2. **Inserisci il codice sconto** che ti ha dato il tuo rivenditore, se lo hai.
3. **Concludi l'acquisto**



## Dati Tecnici / Technical Data

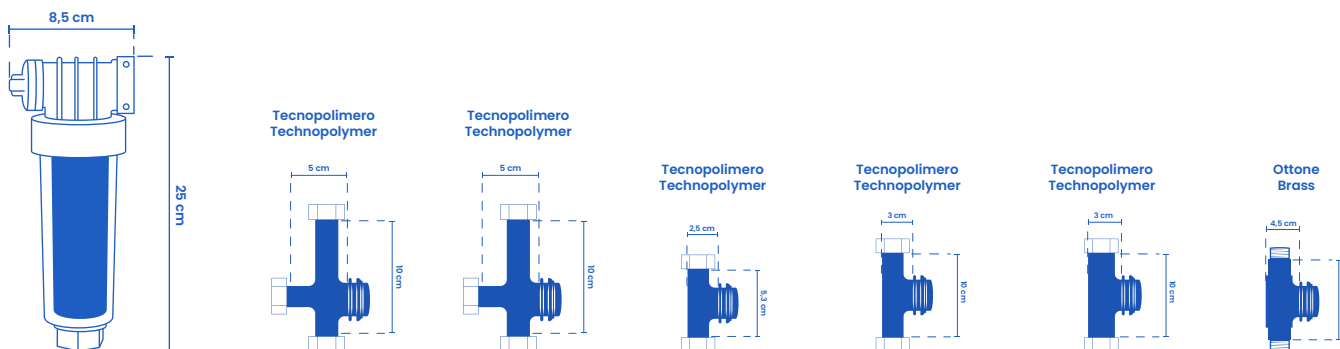

Raccordi In/Out - Fittings In/Out	IN 1/2" F OUT 1/2" F	IN 3/4" F OUT 3/4" F	IN 1/2" F OUT 1/2" F	IN 3/4" F OUT 3/4" F	IN 1" F OUT 1" F	IN 3/4" F OUT 3/4" F
Pressione Max. - Max Pressure	6 bar	6 bar	6 bar	6 bar	6 bar	6 bar
Filtrazione - Filtration	90 µm	90 µm	90 µm	90 µm	90 µm	90 µm
Portata - Flow Rate	2 m³/h (ΔP 0.2 bar)	3 m³/h (ΔP 0.2 bar)	2 m³/h (ΔP 0.2 bar)	3 m³/h (ΔP 0.2 bar)	3,5 m³/h (ΔP 0.2 bar)	3 m³/h (ΔP 0.2 bar)
Temp. ambiente - Ambient temperature	5-40 °C	5-40 °C	5-40 °C	5-40 °C	5-40 °C	5-40 °C
Uso - Use	Potabile Tecnico Potable-Technical	Potabile Tecnico Potable-Technical	Potabile Tecnico Potable-Technical	Potabile Tecnico Potable-Technical	Potabile Tecnico Potable-Technical	Potabile Tecnico Potable-Technical
Materiale - Material	PA-SAN-PE	PA-SAN-PE	PA-SAN-PE	PA-SAN-PE	PA-SAN-PE	PA-SAN-PE-Ottone (brass)
Autonomia - Refill Capacity	130 m³/h	130 m³/h	130 m³/h	130 m³/h	130 m³/h	130 m³/h
By-pass integrato - Integrated bypass	Si / Yes	Si / Yes	Si / Yes	Si / Yes	Si / Yes	Si / Yes
Dosaggio inferiore al. - Dosage Less Than	5 mg/L	5 mg/L	5 mg/L	5 mg/L	5 mg/L	5 mg/L